

Lifecube Single-use Bags



Lifecube Single-use Bags

The single-use system is a process equipment solution. Compared with the traditional stainless steel system, it has the advantages of lower initial cost, no cleaning, and speeding up the development and production progress. At present, it has been widely used in the field of biopharmaceuticals, such as vaccines, antibodies, gene and cell therapy, etc., in all processes from cell culture to preparation filling.

Cobetter Lifecube single-use bags are exclusively designed by Hangzhou Cobetter Filtration Equipment Co., Ltd. The entire manufacturing process of Cobetter Lifecube single-use bags from raw material storage to product packaging is completed in the ISO Class 7 clean zones. Cobetter establishes and continuously maintains the company's quality assurance system in accordance with the requirements of ISO® 9001:2015 quality management system and cGMP. All the products are manufactured under strict quality system to ensure stable and reliable quality. Cobetter Lifecube can help you achieve simpler process, greater process efficiency and productivity, easier verification and safer products.

- The films have low extractables, low precipitation, good physical strength, chemical compatibility and biocompatibility
- High transparency film is conducive to auxiliary process judgment
- It can meet all kinds of storage and transportation needs in the biopharmaceutical processes
- Flexible custom size and tubings, suitable for various processes

Features

- The film has low level of extractables and leachables, good physical strength, chemical compatibility and biocompatibility
- Easy to process judgment for high transparency film
- Meet the requirements of various solutions storage and transfer in the biopharmaceutical process
- Flexibly design bags and tubings for various processes

Typical Applications

- Buffer and media preparation, storage and transfer
- Preparation of bioreactor feeds
- Purified components collection
- Storage of purified intermediates
- Stock solution storage and transfer
- Formulation filling







Lifecube Film I

Specifications

Netherlands Renolit 9101 and Lifemeta KA, the films of Cobetter Lifecube single-use bags, are composed of five layers. The thickness, materials and performance of each layer are given below.

Netherlands Renolit 9101 Film

	230µm	ULDPE Fluid contact layer, ultra-low density polyethylene	Low extractables & leachables, broad chemical compatibility and biological safety.
	10µm	Tie Bonding layer	
	20µm	EVOH Gas barrier layer, ethylene vinyl alcohol	Minimizes gas transfusion
	10µm	Tie Bonding layer	
	50µm	LDPE Outer layer, low density polyethylene	Protective layer

Renolit 9101 Film Specifications

Physical Property	Value (Post gamma sterilization, above 25 kGy)	Procedure
Haze	8.0 %	ASTM D-1003
Transmittance	91.7%	ASTM D-1003
Tensile Strength at Break	Transverse 15.2 Lengthways 16.0 , MPa	ASTM D-882
Elongation at Break	Transverse 320 Lengthways 320 , %	ASTM D-882
Elastic Modulus	Transverse 337 Lengthways 332 , MPa	ASTM D-882
Brittleness Temperature by Impact	below -70 °C	ISO 8570
Density	0.923 g/cm ³	ASTM D-792
Water Vapor Transmission Rate	0.331 g/(m ² ·day) (23 °C, 100 % RH)	ASTM F-1249
Oxygen Permeability	0.322 cm ³ /(m ² ·day·bar)	ASTM D-3985
Carbon Dioxide Permeability	0.370 cm ³ /(m ² ·day·bar)	ASTM F-2476
Particulate Matter	Particulate matter in the product eluent meets the requirements in USP <788> for large volume parenterals.	
Bacterial Endotoxin	Aqueous extraction contains < 0.25 EU/mL as determined by Limulus Amebocyte Lysate (LAL),USP <85>.	
USP <87> Cytotoxicity	Meet the requirements of USP <87> in Vitro Biological Reactivity Test.	
USP <88> Biological Reactivity	Meet the criteria of the USP <88> Biological Reactivity Test for Class VI plastics.	
Indirect Food Additive	The fluid contact component materials meet the FDA Indirect Food Additive requirements cited in 21 CFR 177-182.	
Animal Derivative Content	Products do not contain animal derived components and are free from TSE risk.	
Quality Assurance	These products are manufactured in a facility which adheres to ISO® 9001:2015 Practices.	

Lifecube Film II

Lifemeta KA Film

	230µm	ULDPE Fluid contact layer, ultra-low density polyethylene	Low extractables & leachables, broad chemical compatibility and biological safety.
	25µm	Tie Bonding layer	
	20µm	EVOH Gas barrier layer, ethylene vinyl alcohol	Minimizes gas transfection
	25µm	Tie Bonding layer	
	30µm	HDPE Outer layer, high density polyethylene	Protective layer

Lifemeta KA Film Specifications

Physical Property	Value (Post gamma sterilization, above 25 kGy)	Procedure
Haze	21.2 %	ASTM D-1003
Transmittance	90.2%	ASTM D-1003
Tensile Strength at Break	Transverse 21.9 Lengthways 26.7 , MPa	ASTM D-882
Elongation at Break	Transverse 380 Lengthways 420 , %	ASTM D-882
Elastic Modulus	Transverse 277 Lengthways 289 , MPa	ASTM D-882
Brittleness Temperature by Impact	below -70 °C	ISO 8570
Density	0.941 g/cm ³	ASTM D-792
Water Vapor Transmission Rate	0.593 g/(m ² ·day) (23 °C, 100 % RH)	ASTM F-1249
Oxygen Permeability	1.024 cm ³ /(m ² ·day·bar)	ASTM D-3985
Carbon Dioxide Permeability	1.455 cm ³ /(m ² ·day·bar)	ASTM F-2476
Particulate Matter	Particulate matter in the product eluent meets the requirements in USP <788> for large volume parenterals.	
Bacterial Endotoxin	Aqueous extraction contains < 0.25 EU/mL as determined by Limulus Amebocyte Lysate (LAL),USP <85>.	
USP <87> Cytotoxicity	Meet the requirements of USP <87> in Vitro Biological Reactivity Test.	
USP <88> Biological Reactivity	Meet the criteria of the USP <88> Biological Reactivity Test for Class VI plastics.	
Indirect Food Additive	The fluid contact component materials meet the FDA Indirect Food Additive requirements cited in 21 CFR 177-182.	
Animal Derivative Content	Products do not contain animal derived components and are free from TSE risk.	
Quality Assurance	These products are manufactured in a facility which adheres to ISO® 9001:2015 Practices.	



Lifecube 2D/3D Single-use Bags

Quality Assurance

- ISO® 9001:2015 quality management system
- ISO Class 7 clean zones
- 100% leak testing for Lifecube® 2D single-use bags
- ADCF raw materials
- Meet the FDA Indirect Food Additive requirements cited in 21 CFR 177-182
- Meet the requirement of USP <87> In Vitro Biological Reactivity Test
- Meet the criteria of the USP <88> Biological Reactivity Test for Class VI plastics

Features

- Good physical strength and excellent biological safety
- Integrated bag body designed for Lifecube® 2D single-use bags and less residual liquid
- Double-layer sterile packaging sterilized by 25-45 kGy gamma irradiation
- Variable and flexible customized services
- Various and scalable

Typical Applications

- Buffer and media storage and transfer after filtration
- Intermediates storage
- Stock solution storage
- Formulation filling

- Aqueous extraction contains <0.25 EU/mL as determined by Limulus Amebocyte Lysate (LAL), USP <85>
- Particulate matter in the product eluent meets the requirements in USP <788> for large volume parenterals
- Verify gamma irradiation dose according to ISO® 11137
- Provide product Validation Guide and Certificate of Quality





Lifecube AS Single-use Sampling Bags

Quality Assurance

- ISO® 9001:2015 quality management system
- ISO Class 7 clean zones
- 100% leak testing
- ADCF raw materials
- Meet the FDA Indirect Food Additive requirements cited in 21 CFR 177-182
- Meet the requirement of USP <87> In Vitro Biological Reactivity Test
- Meet the criteria of the USP <88> Biological Reactivity Test for Class VI plastics
- Aqueous extraction contains < 0.25 EU/mL as determined by Limulus Amebocyte Lysate (LAL), USP <85>
- Particulate matter in the product eluent meets the requirements in USP <788> for large volume parenterals
- Verify gamma irradiation dose according to ISO® 11137

Features

- Good physical strength and excellent biological safety
- Integrated bag body and less residual liquid
- Double-layer sterile packaging sterilized by 25-45 kGy gamma irradiation
- Various choices for sampling application
- Variable and flexible customized services

Typical Applications

- Sampling with single-use bags
- Secondary sampling from sampling bag
- Store samples after sampling

Buffer and Media Applications

Lifemeta STT Pt-cured Silicone Tubing

Volume	Line 1	Line 2	Cat. No.1(9101 Film)	Cat. No2(KA Film)
5ml	20 cm ID 1/8" * OD 1/4" Lifemeta STT Pt-cured Silicone Tubing + Male Luer Lock + Sealing Cap	None	AS5ML1TLN	KAS5ML1TLN
50ml	20 cm ID 1/8" * OD 1/4" Lifemeta STT Pt-cured Silicone Tubing + Male Luer Lock + Sealing Cap	20 cm ID 1/8" * OD 1/4" Lifemeta STT Pt-cured Silicone Tubing + Female Luer Lock + Needlefree Swabable Valve	AS0051TLF	KAS0051TLF
50ml	20 cm ID 1/8" * OD 1/4" Lifemeta STT Pt-cured Silicone Tubing + Male Luer Lock + Sealing Cap	20 cm ID 1/8" * OD 1/4" Lifemeta STT Pt-cured Silicone Tubing + Female Luer Lock + Sampling Plug	AS0051TLV	KAS0051TLV
50ml	20 cm ID 1/8" * OD 1/4" Lifemeta STT Pt-cured Silicone Tubing + Male Luer Lock + Sealing Cap	20 cm ID 1/8" * OD 1/4" Lifemeta STT Pt-cured Silicone Tubing + Female Luer Lock + Sealing Cap	AS0051TLC	KAS0051TLC
50ml	20 cm ID 1/8" * OD 1/4" Lifemeta STT Pt-cured Silicone Tubing + Female Luer Lock+ Sealing Cap	20 cm ID 1/8" * OD 1/4" Lifemeta STT Pt-cured Silicone Tubing + Female Luer Lock + Needlefree Swabable Valve	AS0051TEF	KAS0051TEF
100ml	20 cm ID 1/8" * OD 1/4" Lifemeta STT Pt-cured Silicone Tubing + Male Luer Lock + Sealing Cap	20 cm ID 1/8" * OD 1/4" Lifemeta STT Pt-cured Silicone Tubing + Female Luer Lock + Needlefree Swabable Valve	AS0101TLF	KAS0101TLF
100ml	20 cm ID 1/8" * OD 1/4" Lifemeta STT Pt-cured Silicone Tubing + Male Luer Lock + Sealing Cap	20 cm ID 1/8" * OD 1/4" Lifemeta STT Pt-cured Silicone Tubing + Female Luer Lock + Sampling Plug	AS0101TLV	KAS0101TLV
100ml	20 cm ID 1/8" * OD 1/4" Lifemeta STT Pt-cured Silicone Tubing + Male Luer Lock + Sealing Cap	20 cm ID 1/8" * OD 1/4" Lifemeta STT Pt-cured Silicone Tubing + Female Luer Lock + Sealing Cap	AS0101TLC	KAS0101TLC
100ml	20 cm ID 1/8" * OD 1/4" Lifemeta STT Pt-cured Silicone Tubing + Female Luer Lock+ Sealing Cap	20 cm ID 1/8" * OD 1/4" Lifemeta STT Pt-cured Silicone Tubing + Female Luer Lock + Needlefree Swabable Valve	AS0101TEF	KAS0101TEF
250ml	20 cm ID 1/4" * OD 7/16" Lifemeta STT Pt-cured Silicone Tubing + Male Luer Lock + Sealing Cap	20 cm ID 1/4" * OD 7/16" Lifemeta STT Pt-cured Silicone Tubing + Female Luer Lock + Needlefree Swabable Valve	AS0251TLF	KAS0251TLF
250ml	20 cm ID 1/4" * OD 7/16" Lifemeta STT Pt-cured Silicone Tubing + Male Luer Lock + Sealing Cap	20 cm ID 1/4" * OD 7/16" Lifemeta STT Pt-cured Silicone Tubing + Female Luer Lock + Sampling Plug	AS0251TLV	KAS0251TLV
250ml	20 cm ID 1/4" * OD 7/16" Lifemeta STT Pt-cured Silicone Tubing + Male Luer Lock + Sealing Cap	20 cm ID 1/4" * OD 7/16" Lifemeta STT Pt-cured Silicone Tubing + Female Luer Lock + Sealing Cap	AS0251TLC	KAS0251TLC
500ml	20 cm ID 1/4" * OD 7/16" Lifemeta STT Pt-cured Silicone Tubing + Male Luer Lock + Sealing Cap	20 cm ID 1/4" * OD 7/16" Lifemeta STT Pt-cured Silicone Tubing + Female Luer Lock + Needlefree Swabable Valve	AS0501TLF	KAS0501TLF
500ml	20 cm ID 1/4" * OD 7/16" Lifemeta STT Pt-cured Silicone Tubing + Male Luer Lock + Sealing Cap	20 cm ID 1/4" * OD 7/16" Lifemeta STT Pt-cured Silicone Tubing + Female Luer Lock + Sampling Plug	AS0501TLV	KAS0501TLV
500ml	20 cm ID 1/4" * OD 7/16" Lifemeta STT Pt-cured Silicone Tubing + Male Luer Lock + Sealing Cap	20 cm ID 1/4" * OD 7/16" Lifemeta STT Pt-cured Silicone Tubing + Female Luer Lock + Sealing Cap	AS0501TLC	KAS0501TLC

C-Flex 374 Tubing

Volume	Line 1	Line 2	Cat. No.1(9101 Film)	Cat. No2(KA Film)
5ml	40 cm ID 1/8" * OD 1/4" C-Flex 374 Tubing + Male Luer Lock + Sealing Cap	None	AS5ML1CLN	KAS5ML1CLN
50ml	40 cm ID 1/8" * OD 1/4" C-Flex 374 Tubing + Male Luer Lock + Sealing Cap	40 cm ID 1/8" * OD 1/4" C-Flex 374 Tubing + Female Luer Lock + Needlefree Swabable Valve	AS0051CLF	KAS0051CLF
50ml	40 cm ID 1/8" * OD 1/4" C-Flex 374 Tubing + Male Luer Lock + Sealing Cap	40 cm ID 1/8" * OD 1/4" C-Flex 374 Tubing + Female Luer Lock + Sampling Plug	AS0051CLV	KAS0051CLV
100ml	40 cm ID 1/8" * OD 1/4" C-Flex 374 Tubing + Male Luer Lock + Sealing Cap	40 cm ID 1/8" * OD 1/4" C-Flex 374 Tubing + Female Luer Lock + Needlefree Swabable Valve	AS0101CLF	KAS0101CLF
100ml	40 cm ID 1/8" * OD 1/4" C-Flex 374 Tubing + Male Luer Lock + Sealing Cap	40 cm ID 1/8" * OD 1/4" C-Flex 374 Tubing + Female Luer Lock + Sampling Plug	AS0101CLV	KAS0101CLV
250ml	40 cm ID 1/4" * OD 7/16" C-Flex 374 Tubing + Male Luer Lock + Sealing Cap	40 cm ID 1/4" * OD 7/16" C-Flex 374 Tubing + Female Luer Lock + Needlefree Swabable Valve	AS0251CLF	KAS0251CLF
250ml	40 cm ID 1/8" * OD 1/4" C-Flex 374 Tubing + Male Luer Lock + Sealing Cap	40 cm ID 1/8" * OD 1/4" C-Flex 374 Tubing + Female Luer Lock + Sampling Plug	AS0251CLV	KAS0251CLV
500ml	40 cm ID 1/4" * OD 7/16" C-Flex 374 Tubing + Male Luer Lock + Sealing Cap	40 cm ID 1/4" * OD 7/16" C-Flex 374 Tubing + Female Luer Lock + Needlefree Swabable Valve	AS0501CLF	KAS0501CLF
500ml	40 cm ID 1/4" * OD 7/16" C-Flex 374 Tubing + Male Luer Lock + Sealing Cap	40 cm ID 1/4" * OD 7/16" C-Flex 374 Tubing + Female Luer Lock + Sampling Plug	AS0501CLV	KAS0501CLV

*For more pre-designed solutions, please contact Cobetter sales or technical assistance.

2D Standard Bags Ordering Information IV

Connection via C-Flex 374 Tubing

Volume	Inlet/Outlet	Sampling	Cat. No.1(9101 Film)	Cat. No2(KA Film)
2D 250ml	In Let: 50 cm ID 1/4" * OD 7/16" C-Flex 374 Tubing + Tubing Plug Outlet: 50 cm ID 1/4" * OD 7/16" C-Flex 374 Tubing + Tubing Plug	None	2D025C2NP	K2D025C2NP
2D 500ml	In Let: 50 cm ID 1/4" * OD 7/16" C-Flex 374 Tubing + Tubing Plug Outlet: 50 cm ID 1/4" * OD 7/16" C-Flex 374 Tubing + Tubing Plug	None	2D050C2NP	K2D050C2NP
2D 1L	In Let: 50 cm ID 1/4" * OD 7/16" C-Flex 374 Tubing + Tubing Plug Outlet: 50 cm ID 1/4" * OD 7/16" C-Flex 374 Tubing + Tubing Plug	None	2D01LC2NP	K2D01LC2NP
2D 1L	In Let: 50 cm ID 1/4" * OD 7/16" C-Flex 374 Tubing + Tubing Plug Outlet: 50 cm ID 1/4" * OD 7/16" C-Flex 374 Tubing + Tubing Plug	10 cm ID 1/4" * OD 7/16" C-Flex 374 + Needlefree Swabable Valve	2D01LC21P	K2D01LC21P
2D 1L	In Let: 50 cm ID 1/4" * OD 7/16" C-Flex 374 Tubing + Tubing Plug Outlet: 50 cm ID 1/4" * OD 7/16" C-Flex 374 Tubing + Tubing Plug	40 cm ID 1/4" * OD 7/16" C-Flex 374 + Female Luer Lock + Sealing Plug	2D01LC2CP	K2D01LC2CP
2D 2L	In Let: 50 cm ID 1/4" * OD 7/16" C-Flex 374 Tubing + Tubing Plug Outlet: 50 cm ID 1/4" * OD 7/16" C-Flex 374 Tubing + Tubing Plug	None	2D02LC2NP	K2D02LC2NP
2D 2L	In Let: 50 cm ID 1/4" * OD 7/16" C-Flex 374 Tubing + Tubing Plug Outlet: 50 cm ID 1/4" * OD 7/16" C-Flex 374 Tubing + Tubing Plug	10 cm ID 1/4" * OD 7/16" C-Flex 374 + Needlefree Swabable Valve	2D02LC21P	K2D02LC21P
2D 2L	In Let: 50 cm ID 1/4" * OD 7/16" C-Flex 374 Tubing + Tubing Plug Outlet: 50 cm ID 1/4" * OD 7/16" C-Flex 374 Tubing + Tubing Plug	40 cm ID 1/4" * OD 7/16" C-Flex 374 + Female Luer Lock + Sealing Plug	2D02LC2CP	K2D02LC2CP
2D 5L	In Let: 50 cm ID 3/8" * OD 5/8" C-Flex 374 Tubing + Tubing Plug Outlet: 50 cm ID 3/8" * OD 5/8" C-Flex 374 Tubing + Tubing Plug	None	2D05LC2NP	K2D05LC2NP
2D 5L	In Let: 50 cm ID 3/8" * OD 5/8" C-Flex 374 Tubing + Tubing Plug Outlet: 50 cm ID 3/8" * OD 5/8" C-Flex 374 Tubing + Tubing Plug	10 cm ID 1/4" * OD 7/16" C-Flex 374 + Needlefree Swabable Valve	2D05LC21P	K2D05LC21P
2D 5L	In Let: 50 cm ID 3/8" * OD 5/8" C-Flex 374 Tubing + Tubing Plug Outlet: 50 cm ID 3/8" * OD 5/8" C-Flex 374 Tubing + Tubing Plug	40 cm ID 1/4" * OD 7/16" C-Flex 374 + Female Luer Lock + Sealing Plug	2D05LC2CP	K2D05LC2CP
2D 10L	In Let: 50 cm ID 3/8" * OD 5/8" C-Flex 374 Tubing + Tubing Plug Outlet: 50 cm ID 3/8" * OD 5/8" C-Flex 374 Tubing + Tubing Plug	None	2D10LC2NP	K2D10LC2NP
2D 10L	In Let: 50 cm ID 3/8" * OD 5/8" C-Flex 374 Tubing + Tubing Plug Outlet: 50 cm ID 3/8" * OD 5/8" C-Flex 374 Tubing + Tubing Plug	10 cm ID 1/4" * OD 7/16" C-Flex 374 + Needlefree Swabable Valve	2D10LC21P	K2D10LC21P
2D 10L	In Let: 50 cm ID 3/8" * OD 5/8" C-Flex 374 Tubing + Tubing Plug Outlet: 50 cm ID 3/8" * OD 5/8" C-Flex 374 Tubing + Tubing Plug	40 cm ID 1/4" * OD 7/16" C-Flex 374 + Female Luer Lock	2D10LC2CP	K2D10LC2CP
2D 20L	In Let: 50 cm ID 3/8" * OD 5/8" C-Flex 374 Tubing + Tubing Plug Outlet: 50 cm ID 3/8" * OD 5/8" C-Flex 374 Tubing + Tubing Plug	None	2D20LC2NP	K2D20LC2NP
2D 20L	In Let: 50 cm ID 3/8" * OD 5/8" C-Flex 374 Tubing + Tubing Plug Outlet: 50 cm ID 3/8" * OD 5/8" C-Flex 374 Tubing + Tubing Plug	10 cm ID 1/4" * OD 7/16" C-Flex 374 + Needlefree Swabable Valve	2D20LC21P	K2D20LC21P
2D 20L	In Let: 50 cm ID 3/8" * OD 5/8" C-Flex 374 Tubing + Tubing Plug Outlet: 50 cm ID 3/8" * OD 5/8" C-Flex 374 Tubing + Tubing Plug	40 cm ID 1/4" * OD 7/16" C-Flex 374 + Female Luer Lock + Sealing Plug	2D20LC2CP	K2D20LC2CP
2D 20L	In Let: 50 cm ID 3/8" * OD 5/8" C-Flex 374 Tubing + 3/4" Tri-clamp (TC25) Outlet: 50 cm ID 3/8" * OD 5/8" C-Flex 374 Tubing + 3/4" Tri-clamp (TC25)	10 cm ID 1/4" * OD 7/16" C-Flex 374 + Needlefree Swabable Valve	2D20LC21T	K2D20LC21T
2D 35L	In Let: 50 cm ID 3/8" * OD 5/8" C-Flex 374 Tubing + Tubing Plug Outlet: 50 cm ID 3/8" * OD 5/8" C-Flex 374 Tubing + Tubing Plug	None	2D35LC2NP	K2D35LC2NP
2D 35L	In Let: 50 cm ID 3/8" * OD 5/8" C-Flex 374 Tubing + Tubing Plug Outlet: 50 cm ID 3/8" * OD 5/8" C-Flex 374 Tubing + Tubing Plug	10 cm ID 1/4" * OD 7/16" C-Flex 374 + Needlefree Swabable Valve	2D35LC21P	K2D35LC21P
2D 35L	In Let: 50 cm ID 3/8" * OD 5/8" C-Flex 374 Tubing + Tubing Plug Outlet: 50 cm ID 3/8" * OD 5/8" C-Flex 374 Tubing + Tubing Plug	40 cm ID 1/4" * OD 7/16" C-Flex 374 + Female Luer Lock + Sealing Plug	2D35LC2CP	K2D35LC2CP
2D 50L	In Let: 50 cm ID 3/8" * OD 5/8" C-Flex 374 Tubing + Tubing Plug Outlet: 50 cm ID 3/8" * OD 5/8" C-Flex 374 Tubing + Tubing Plug	None	2D50LC2NP	K2D50LC2NP
2D 50L	In Let: 50 cm ID 3/8" * OD 5/8" C-Flex 374 Tubing + Tubing Plug Outlet: 50 cm ID 3/8" * OD 5/8" C-Flex 374 Tubing + Tubing Plug	10 cm ID 1/4" * OD 7/16" C-Flex 374 + Needlefree Swabable Valve	2D50LC21P	K2D50LC21P
2D 50L	In Let: 50 cm ID 3/8" * OD 5/8" C-Flex 374 Tubing + Tubing Plug Outlet: 50 cm ID 3/8" * OD 5/8" C-Flex 374 Tubing + Tubing Plug	40 cm ID 1/4" * OD 7/16" C-Flex 374 + Female Luer Lock + Sealing Plug	2D50LC2CP	K2D50LC2CP
2D 50L	In Let: 50 cm ID 3/8" * OD 5/8" C-Flex 374 Tubing + 3/8" HB MPC Coupling Bodies Outlet: 50 cm ID 3/8" * OD 5/8" C-Flex 374 Tubing + 3/8" HB MPC Coupling Inserts	10 cm ID 1/4" * OD 7/16" C-Flex 374 + Needlefree Swabable Valve	2D50LC21C	K2D50LC21C

*For more pre-designed solutions, please contact Cobetter sales or technical assistance.

3D Standard Bags Ordering Information I

Connection via MPC/MPX Quick Couplers

Volume	Inlet/Outlet	Sampling	Cat. No.1(9101 Film)	Cat. No2(KA Film)
3D 50L	Inlet: 100 cm ID 3/8" * OD 3/8" Lifemeta STT Pt-cured Silicone Tubing + 3/8" HB MPC Coupling Bodies Outlet: 100 cm ID 3/8" * OD 3/8" Lifemeta STT Pt-cured Silicone Tubing + 3/8" HB MPC Coupling Inserts	20 cm ID 1/4" * OD 7/16" Lifemeta STT Pt-cured Silicone Tubing + Needlefree Swabable Valve	3D50LT21C	K3D50LT21C
3D 100L	Inlet: 150 cm ID 3/8" * OD 3/8" Lifemeta STT Pt-cured Silicone Tubing + 3/8" HB MPC Coupling Bodies Outlet: 150 cm ID 3/8" * OD 3/8" Lifemeta STT Pt-cured Silicone Tubing + 3/8" HB MPC Coupling Inserts	None	3D100T2NC	K3D100T2NC
3D 100L	Inlet: 150 cm ID 3/8" * OD 3/8" Lifemeta STT Pt-cured Silicone Tubing + 3/8" HB MPC Coupling Bodies Outlet: 150 cm ID 3/8" * OD 3/8" Lifemeta STT Pt-cured Silicone Tubing + 3/8" HB MPC Coupling Inserts	20 cm ID 1/4" * OD 7/16" Lifemeta STT Pt-cured Silicone Tubing + Needlefree Swabable Valve	3D100T21C	K3D100T21C
3D 200L	Inlet: 150 cm ID 3/8" * OD 3/8" Lifemeta STT Pt-cured Silicone Tubing + 3/8" HB MPC Coupling Bodies Outlet: 150 cm ID 3/8" * OD 3/8" Lifemeta STT Pt-cured Silicone Tubing + 3/8" HB MPC Coupling Inserts	None	3D200T2NC	K3D200T2NC
3D 200L	Inlet: 150 cm ID 3/8" * OD 3/8" Lifemeta STT Pt-cured Silicone Tubing + 3/8" HB MPC Coupling Bodies Outlet: 150 cm ID 3/8" * OD 3/8" Lifemeta STT Pt-cured Silicone Tubing + 3/8" HB MPC Coupling Inserts	20 cm ID 1/4" * OD 7/16" Lifemeta STT Pt-cured Silicone Tubing + Needlefree Swabable Valve	3D200T21C	K3D200T21C
3D 250L	Inlet: 150 cm ID 1/2" * OD 3/4" Lifemeta STT Pt-cured Silicone Tubing + 1/2" HB MPX Coupling Bodies Outlet: 150 cm ID 1/2" * OD 3/4" Lifemeta STT Pt-cured Silicone Tubing + 1/2" HB MPX Coupling Inserts	20 cm ID 1/4" * OD 7/16" Lifemeta STT Pt-cured Silicone Tubing + Needlefree Swabable Valve	3D250T1C	K3D250T21C
3D 500L	Inlet: 150 cm ID 1/2" * OD 3/4" Lifemeta STT Pt-cured Silicone Tubing + 1/2" HB MPX Coupling Bodies Outlet: 150 cm ID 1/2" * OD 3/4" Lifemeta STT Pt-cured Silicone Tubing + 1/2" HB MPX Coupling Inserts	20 cm ID 1/4" * OD 7/16" Lifemeta STT Pt-cured Silicone Tubing + Needlefree Swabable Valve	3D500T21C	K3D500T21C
3D 1000L	Inlet: 150 cm ID 1/2" * OD 3/4" Lifemeta STT Pt-cured Silicone Tubing + 1/2" HB MPX Coupling Bodies Outlet: 150 cm ID 1/2" * OD 3/4" Lifemeta STT Pt-cured Silicone Tubing + 1/2" HB MPX Coupling Inserts	20 cm ID 1/4" * OD 7/16" Lifemeta STT Pt-cured Silicone Tubing + Needlefree Swabable Valve	3D10XT21C	K3D10XT21C
3D 2000L	Inlet: 150 cm ID 1/2" * OD 3/4" Lifemeta STT Pt-cured Silicone Tubing + 1/2" HB MPX Coupling Bodies Outlet: 300 cm ID 1/2" * OD 3/4" Lifemeta STT Pt-cured Silicone Tubing + 1/2" HB MPX Coupling Inserts	20 cm ID 1/4" * OD 7/16" Lifemeta STT Pt-cured Silicone Tubing + Needlefree Swabable Valve	3D20XT1C	K3D20XT21C
3D 3000L	Inlet: 150 cm ID 1/2" * OD 3/4" Lifemeta STT Pt-cured Silicone Tubing + 1/2" HB MPX Coupling Bodies Outlet: 300 cm ID 1/2" * OD 3/4" Lifemeta STT Pt-cured Silicone Tubing + 1/2" HB MPX Coupling Inserts	20 cm ID 1/4" * OD 7/16" Lifemeta STT Pt-cured Silicone Tubing + Needlefree Swabable Valve	3D20XT21C	K3D20XT21C

Connection via Tri-clamps(TC)

Volume	Inlet/Outlet	Sampling	Cat. No.1(9101 Film)	Cat. No2(KA Film)
3D 50L	Inlet: 100 cm ID 3/8" * OD 3/8" Lifemeta STT Pt-cured Silicone Tubing + 3/4" Tri-clamp(TC25) Outlet: 100 cm ID 3/8" * OD 3/8" Lifemeta STT Pt-cured Silicone Tubing + 3/4" Tri-clamp(TC25)	20 cm ID 1/4" * OD 7/16" Lifemeta STT Pt-cured Silicone Tubing + Needlefree Swabable Valve	3D50LT21T	K3D50LT21T
3D 100L	Inlet: 150 cm ID 3/8" * OD 3/8" Lifemeta STT Pt-cured Silicone Tubing + 1-1/2" Tri-clamp(TC25) Outlet: 150 cm ID 3/8" * OD 3/8" Lifemeta STT Pt-cured Silicone Tubing + 1-1/2" Tri-clamp(TC25)	20 cm ID 1/4" * OD 7/16" Lifemeta STT Pt-cured Silicone Tubing + Needlefree Swabable Valve	3D100T21S	K3D100T21S
3D 200L	Inlet: 150 cm ID 3/8" * OD 3/8" Lifemeta STT Pt-cured Silicone Tubing + 1-1/2" Tri-clamp(TC25) Outlet: 150 cm ID 3/8" * OD 3/8" Lifemeta STT Pt-cured Silicone Tubing + 1-1/2" Tri-clamp(TC25)	20 cm ID 1/4" * OD 7/16" Lifemeta STT Pt-cured Silicone Tubing + Needlefree Swabable Valve	3D200T21S	K3D200T21S
3D 250L	Inlet: 150 cm ID 1/2" * OD 3/4" Lifemeta STT Pt-cured Silicone Tubing + 1-1/2" Tri-clamp(TC25) Outlet: 150 cm ID 1/2" * OD 3/4" Lifemeta STT Pt-cured Silicone Tubing + 1-1/2" Tri-clamp(TC25)	20 cm ID 1/4" * OD 7/16" Lifemeta STT Pt-cured Silicone Tubing + Needlefree Swabable Valve	3D250T21S	K3D250T21S
3D 500L	Inlet: 150 cm ID 1/2" * OD 3/4" Lifemeta STT Pt-cured Silicone Tubing + 1-1/2" Tri-clamp(TC25) Outlet: 150 cm ID 1/2" * OD 3/4" Lifemeta STT Pt-cured Silicone Tubing + 1-1/2" Tri-clamp(TC25)	20 cm ID 1/4" * OD 7/16" Lifemeta STT Pt-cured Silicone Tubing + Needlefree Swabable Valve	3D500T21S	K3D500T21S
3D 1000L	Inlet: 150 cm ID 1/2" * OD 3/4" Lifemeta STT Pt-cured Silicone Tubing + 1-1/2" Tri-clamp(TC25) Outlet: 150 cm ID 1/2" * OD 3/4" Lifemeta STT Pt-cured Silicone Tubing + 1-1/2" Tri-clamp(TC25)	20 cm ID 1/4" * OD 7/16" Lifemeta STT Pt-cured Silicone Tubing + Needlefree Swabable Valve	3D10XT21S	K3D10XT21S

3D Standard Bags Ordering Information II

Connection via AseptiQuik Connectors

Volume	Inlet/Outlet	Sampling	Cat. No.1(9101 Film)	Cat. No2(KA Film)
3D 50L	Inlet: 100 cm ID 3/8" * OD 3/8" Lifemeta STT Pt-cured Silicone Tubing + AseptiQuik G Connector Outlet: 100 cm ID 3/8" * OD 3/8" Lifemeta STT Pt-cured Silicone Tubing + AseptiQuik G Connector	20 cm ID 1/4" * OD 7/16" Lifemeta STTPt-cured Silicone Tubing+Needlefree Swabable Valve	3D50LT21A	K3D50LT21A
3D 100L	Inlet: 150 cm ID 3/8" * OD 3/8" Lifemeta STT Pt-cured Silicone Tubing + AseptiQuik G Connector Outlet: 150 cm ID 3/8" * OD 3/8" Lifemeta STT Pt-cured Silicone Tubing + AseptiQuik G Connector	None	3D100T21A	K3D100T21A
3D 200L	Inlet: 150 cm ID 3/8" * OD 3/8" Lifemeta STT Pt-cured Silicone Tubing + AseptiQuik G Connector Outlet: 150 cm ID 3/8" * OD 3/8" Lifemeta STT Pt-cured Silicone Tubing + AseptiQuik G Connector	20 cm ID 1/4" * OD 7/16" Lifemeta STTPt-cured Silicone Tubing+Needlefree Swabable Valve	3D200T2NA	K3D200T2NA
3D 200L	Inlet: 150 cm ID 3/8" * OD 3/8" Lifemeta STT Pt-cured Silicone Tubing + AseptiQuik G Connector Outlet: 150 cm ID 3/8" * OD 3/8" Lifemeta STT Pt-cured Silicone Tubing + AseptiQuik G Connector	None	3D200T21A	K3D200T21A
3D 250L	Inlet: 150 cm ID 1/2" * OD 3/4" Lifemeta STT Pt-cured Silicone Tubing + AseptiQuik G Connector Outlet: 150 cm ID 1/2" * OD 3/4" Lifemeta STT Pt-cured Silicone Tubing + AseptiQuik G Connector	20 cm ID 1/4" * OD 7/16" Lifemeta STTPt-cured Silicone Tubing+Needlefree Swabable Valve	3D250T21A	K3D250T21A
3D 500L	Inlet: 150 cm ID 1/2" * OD 3/4" Lifemeta STT Pt-cured Silicone Tubing + AseptiQuik G Connector Outlet: 150 cm ID 1/2" * OD 3/4" Lifemeta STT Pt-cured Silicone Tubing + AseptiQuik G Connector	20 cm ID 1/4" * OD 7/16" Lifemeta STTPt-cured Silicone Tubing+Needlefree Swabable Valve	3D500T21A	K3D500T21A
3D 1000L	Inlet: 150 cm ID 1/2" * OD 3/4" Lifemeta STT Pt-cured Silicone Tubing + AseptiQuik G Connector Outlet: 150 cm ID 1/2" * OD 3/4" Lifemeta STT Pt-cured Silicone Tubing + AseptiQuik G Connector	20 cm ID 1/4" * OD 7/16" Lifemeta STTPt-cured Silicone Tubing+Needlefree Swabable Valve	3D10XT21A	K3D10XT21A
3D 2000L	Inlet: 150 cm ID 1/2" * OD 3/4" Lifemeta STT Pt-cured Silicone Tubing + AseptiQuik G Connector Outlet: 300 cm ID 1/2" * OD 3/4" Lifemeta STT Pt-cured Silicone Tubing + AseptiQuik G Connector	20 cm ID 1/4" * OD 7/16" Lifemeta STTPt-cured Silicone Tubing+Needlefree Swabable Valve	3D20XT21A	K3D20XT21A
3D 3000L	Inlet: 150 cm ID 1/2" * OD 3/4" Lifemeta STT Pt-cured Silicone Tubing + AseptiQuik G Connector Outlet: 300 cm ID 1/2" * OD 3/4" Lifemeta STT Pt-cured Silicone Tubing + AseptiQuik G Connector	20 cm ID 1/4" * OD 7/16" Lifemeta STTPt-cured Silicone Tubing+Needlefree Swabable Valve	3D30XT21A	K3D30XT21A

Connection C-Flex 374 Tubing

Volume	Inlet/Outlet	Sampling	Cat. No.1(9101 Film)	Cat. No2(KA Film)
3D 50L	Inlet: 100 cm ID 3/8" * OD 3/8" C-Flex 374 Tubing + Tubing Plug Outlet: 100 cm ID 3/8" * OD 3/8" C-Flex 374 Tubing + Tubing Plug	40 cm ID 1/4" * OD 7/16" C-Flex 374 Tubing +Female Luer Lock+ Tubing Plug	3D50LC2CP	K3D50LC2CP
3D 100L	Inlet: 150 cm ID 3/8" * OD 3/8" C-Flex 374 Tubing + Tubing Plug Outlet: 150 cm ID 3/8" * OD 3/8" C-Flex 374 Tubing + Tubing Plug	40 cm ID 1/4" * OD 7/16" C-Flex 374 Tubing +Female Luer Lock+ Tubing Plug	3D100C2CP	K3D100C2CP
3D 200L	Inlet: 150 cm ID 3/8" * OD 3/8" C-Flex 374 Tubing + Tubing Plug Outlet: 150 cm ID 3/8" * OD 3/8" C-Flex 374 Tubing + Tubing Plug	40 cm ID 1/4" * OD 7/16" C-Flex 374 Tubing +Female Luer Lock+ Tubing Plug	3D200C2CP	K3D200C2CP
3D 250L	Inlet: 150 cm ID 1/2" * OD 3/4" C-Flex 374 Tubing + Tubing Plug Outlet: 150 cm ID 1/2" * OD 3/4" C-Flex 374 Tubing + Tubing Plug	40 cm ID 1/4" * OD 7/16" C-Flex 374 Tubing +Female Luer Lock+ Tubing Plug	3D250C2CP	K3D250C2CP
3D 500L	Inlet: 150 cm ID 1/2" * OD 3/4" C-Flex 374 Tubing + Tubing Plug Outlet: 150 cm ID 1/2" * OD 3/4" C-Flex 374 Tubing + Tubing Plug	40 cm ID 1/4" * OD 7/16" C-Flex 374 Tubing +Female Luer Lock+ Tubing Plug	3D500C2CP	K3D500C2CP
3D 1000L	Inlet: 150 cm ID 1/2" * OD 3/4" C-Flex 374 Tubing + Tubing Plug Outlet: 150 cm ID 1/2" * OD 3/4" C-Flex 374 Tubing + Tubing Plug	40 cm ID 1/4" * OD 7/16" C-Flex 374 Tubing +Female Luer Lock+ Tubing Plug	3D10XC2CP	K3D10XC2CP

Supporting Containers

- Supporting container with 2D storage bag, 3D storage bag and 3D mixing bag;
- The material is 304L, and the outer surface can be mechanical polished or electro-polished;
- The box can be square or round. Single layer or multiple layers (with stainless steel jacket for temperature control);
- Optional weighing module, temperature transmitter, bottom magnetic mixing, pH, conductivity, dissolved oxygen, TCU equipment, HMI, data storage system;
- With special polyurethane universal casters for clean areas, which can move flexibly;
- The outlet at the bottom of the box is convenient for drainage;
- The side of the project can adopt an operating door and a viewing window to facilitate observation of the liquid state



Features

- The container to support the bag can be provided separately to match the bag of the competing bags; it can also be matched with the company's own products
- The factory has more than 3,000 m2 housing manufacturing workshops, which can efficiently provide stainless steel cabinets and support systems;
- A complete quality system can cooperate with customers to complete the calibration work of the trolley system;
- The after-sales service responds quickly, 24h response.

Product Type

- 2D storage bag supporting tray, multi-layer tray;
- 50L-3000L liquid storage support container;
- 50L-2000L stirring support container.



Lifecube Single-Use Transfer Sets

Single-use tubing assemblies are critical for transfers between single-use and hybrid systems. With **Cobetter Single-use Transfer Sets**, you can easily connect multiple containers, vessels and process lines in one system. The extension set is available in a variety of tubing sizes and lengths to meet your fluid transfer needs.

Lifemeta STT Silicone Tubing is a highly resistant platinum-cured silicone tubing, with very low extractable for the transfer of critical fluids and suitable for pumping application.

Lifemeta STF TPE Tubing is a highly resistant sealable and weldable thermoplastic elastomer tubing, features smooth inner bore for superior fluid flow.



Features

- Ready to use, saving time and reducing costs
- Streamline the collection and transfer of samples
- Minimizing the risk of cross-contamination
- Custom assemblies are available

Quality Assurance

- ISO 9001:2015 quality management system
- Manufactured in ISO Class 7 clean room
- 100% leak testing
- ADCF raw material, meets the FDA Indirect Food Additive requirements cited in 21 CFR 177-182
- Meets the requirement of USP <87> In Vitro Biological Reactivity Test
- Meets the criteria of the USP <88> Biological Reactivity Test for Class VI plastics
- Aqueous extraction contains < 0.25 EU/mL as determined by Limulus Amebocyte Lysate (LAL), USP <85>
- Particulate matter in the product eluent meets the requirements in USP <788> for large volume parenterals
- Verify gamma irradiation dose of sterile packaging according to ISO 11137

Applications

- Buffer and media transfer
- Collecting samples
- Media filtration
- Removal of liquids from bioprocess
- Carboy Assemblies
- Peristaltic Pump Tube assemblies

Single-Use Extension Transfer Sets with TPE Tubing Plugs



Part No.	Port 1	Tubing	Length	Port 2	Package
SAL01001			50 cm		1 set
SAL01002	Plug	ID1/8" * OD1/4" C-Flex® 374	100 cm	Plug	1 set
SAL01003			250 cm		1 set
SAL01004			50 cm		1 set
SAL01005	Plug	ID1/4" * OD7/16" C-Flex® 374	100 cm	Plug	1 set
SAL01006			250 cm		1 set
SAL01007			50 cm		1 set
SAL01008	Plug	ID3/8" * OD5/8" C-Flex® 374	100 cm	Plug	1 set
SAL01009			250 cm		1 set
SAL01010			50 cm		1 set
SAL01011	Plug	ID1/2" * OD3/4" C-Flex® 374	100 cm	Plug	1 set
SAL01012			250 cm		1 set
SAL01013			50 cm		1 set
SAL01014	Plug	ID1/8" * OD1/4" Lifemeta STF	100 cm	Plug	1 set
SAL01015			250 cm		1 set
SAL01016			50 cm		1 set
SAL01017	Plug	ID1/4" * OD7/16" Lifemeta STF	100 cm	Plug	1 set
SAL01018			250 cm		1 set
SAL01019			50 cm		1 set
SAL01020	Plug	ID3/8" * OD5/8" Lifemeta STF	100 cm	Plug	1 set
SAL01021			250 cm		1 set
SAL01022			50 cm		1 set
SAL01023	Plug	ID1/2" * OD3/4" Lifemeta STF	100 cm	Plug	1 set
SAL01024			250 cm		1 set

Single-Use Extension Transfer Sets with Lifemeta STT Pt-cured Silicone Tubing EC Connectors



Part No.	Port 1	Tubing	Length	Port 2	Package
SAL02019			50 cm		1 set
SAL02020	ECS Female	ID1/8" * OD1/4" Lifemeta STT	100 cm	ECS Male	1 set
SAL02021			250 cm		1 set
SAL02022			50 cm		1 set
SAL02023	ECS Female	ID1/4" * OD7/16" Lifemeta STT	100 cm	ECS Male	1 set
SAL02024			250 cm		1 set
SAL02025			50 cm		1 set
SAL02026	ECS Female	ID3/8" * OD5/8" Lifemeta STT	100 cm	ECS Male	1 set
SAL02027			250 cm		1 set
SAL02028			50 cm		1 set
SAL02029	ECM Female	ID1/2" * OD3/4" Lifemeta STT	100 cm	ECM Male	1 set
SAL02030			250 cm		1 set
SAL02031		ID1/8" * OD1/4" Lifemeta STT	100 cm		1 set
SAL02032	ECS Male	ID1/4" * OD7/16" Lifemeta STT	100 cm	TC25	1 set
SAL02033		ID3/8" * OD5/8" Lifemeta STT	100 cm		1 set
SAL02034		ID1/4" * OD7/16" Lifemeta STT	100 cm		1 set
SAL02035	ECS Male	ID3/8" * OD5/8" Lifemeta STT	100 cm	TC50	1 set
SAL02036	ECM Male	ID1/2" * OD3/4" Lifemeta STT	100 cm	TC50	1 set

**Single-Use Extension Transfer Sets with Lifemeta STT
Pt-cured Silicone Tubing AseptiQuik® G Sterile Connectors**



Part No.	Port 1	Tubing	Length	Port 2	Package
SAL03019			50 cm		1 set
SAL03020		ID1/4" * OD7/16" Lifemeta STT	100 cm		1 set
SAL03021			250 cm		1 set
SAL03022			50 cm	ECS Male	1 set
SAL03023		ID3/8" * OD5/8" Lifemeta STT	100 cm		1 set
SAL03024	AseptiQuik® G Sterile Connectors		250 cm		1 set
SAL03025			50 cm		1 set
SAL03026		ID1/2" * OD3/4" Lifemeta STT	100 cm	ECM Male	1 set
SAL03027			250 cm		1 set
SAL03028		ID1/4" * OD7/16" Lifemeta STT	100 cm		1 set
SAL03029		ID3/8" * OD5/8" Lifemeta STT	100 cm	TC25	1 set
SAL03030		ID1/4" * OD7/16" Lifemeta STT	100 cm		1 set
SAL03031		ID3/8" * OD5/8" Lifemeta STT	100 cm	TC50	1 set
SAL03032		ID1/2" * OD3/4" Lifemeta STT	100 cm		1 set

Single-Use Reduction Transfer Sets with TPE Tubing

Figure 1, with tubing plugs



Part No.	Port 1	Tubing	Length	Port 2	Package
SAL04001		ID1/8" * OD1/4" to ID1/4" * OD7/16", C-Flex® 374	50 cm x2		1 set
SAL04002		ID1/8" * OD1/4" to ID1/4" * OD7/16", C-Flex® 374	100 cm x2		1 set
SAL04003		ID1/8" * OD1/4" to ID3/8" * OD5/8", C-Flex® 374	50 cm x2		1 set
SAL04004		ID1/8" * OD1/4" to ID3/8" * OD5/8", C-Flex® 374	100 cm x2		1 set
SAL04005	Plug	ID1/4" * OD7/16" to ID3/8" * OD5/8", C-Flex® 374	50 cm x2	Plug	1 set
SAL04006		ID1/4" * OD7/16" to ID3/8" * OD5/8", C-Flex® 374	100 cm x2		1 set
SAL04007		ID1/4" * OD7/16" to ID1/2" * OD3/4", C-Flex® 374	50 cm x2		1 set
SAL04008		ID1/4" * OD7/16" to ID1/2" * OD3/4", C-Flex® 374	100 cm x2		1 set
SAL04009		ID3/8" * OD5/8" to ID1/2" * OD3/4", C-Flex® 374	50 cm x2		1 set
SAL04010		ID3/8" * OD5/8" to ID1/2" * OD3/4", C-Flex® 374	100 cm x2		1 set
SAL04031		ID1/8" * OD1/4" to ID1/4" * OD7/16", Lifemeta STF	50 cm x2		1 set
SAL04032		ID1/8" * OD1/4" to ID1/4" * OD7/16", Lifemeta STF	100 cm x2		1 set
SAL04033		ID1/8" * OD1/4" to ID3/8" * OD5/8", Lifemeta STF	50 cm x2		1 set
SAL04034		ID1/8" * OD1/4" to ID3/8" * OD5/8", Lifemeta STF	100 cm x2		1 set
SAL04035	Plug	ID1/4" * OD7/16" to ID3/8" * OD5/8", Lifemeta STF	50 cm x2	Plug	1 set
SAL04036		ID1/4" * OD7/16" to ID3/8" * OD5/8", Lifemeta STF	100 cm x2		1 set
SAL04037		ID1/4" * OD7/16" to ID1/2" * OD3/4", Lifemeta STF	50 cm x2		1 set
SAL04038		ID1/4" * OD7/16" to ID1/2" * OD3/4", Lifemeta STF	100 cm x2		1 set
SAL04039		ID3/8" * OD5/8" to ID1/2" * OD3/4", Lifemeta STF	50 cm x2		1 set
SAL04040		ID3/8" * OD5/8" to ID1/2" * OD3/4", Lifemeta STF	100 cm x2		1 set

Figure 2, with EC connectors



Part No.	Port 1	Tubing	Length	Port 2	Package
SAL04011		ID1/8" * OD1/4" to ID1/4" * OD7/16", C-Flex® 374	50 cm x2		1 set
SAL04012		ID1/8" * OD1/4" to ID1/4" * OD7/16", C-Flex® 374	100 cm x2		1 set
SAL04013		ID1/8" * OD1/4" to ID3/8" * OD5/8", C-Flex® 374	50 cm x2	ECS Male	1 set
SAL04014		ID1/8" * OD1/4" to ID3/8" * OD5/8", C-Flex® 374	100 cm x2		1 set
SAL04015	ECS	ID1/4" * OD7/16" to ID3/8" * OD5/8", C-Flex® 374	50 cm x2		1 set
SAL04016	Female	ID1/4" * OD7/16" to ID3/8" * OD5/8", C-Flex® 374	100 cm x2		1 set
SAL04017		ID1/4" * OD7/16" to ID1/2" * OD3/4", C-Flex® 374	50 cm x2		1 set
SAL04018		ID1/4" * OD7/16" to ID1/2" * OD3/4", C-Flex® 374	100 cm x2	ECM	1 set
SAL04019		ID3/8" * OD5/8" to ID1/2" * OD3/4", C-Flex® 374	50 cm x2	Male	1 set
SAL04020		ID3/8" * OD5/8" to ID1/2" * OD3/4", C-Flex® 374	100 cm x2		1 set
SAL04041		ID1/8" * OD1/4" to ID1/4" * OD7/16", Lifemeta STF	50 cm x2		1 set
SAL04042		ID1/8" * OD1/4" to ID1/4" * OD7/16", Lifemeta STF	100 cm x2		1 set
SAL04043		ID1/8" * OD1/4" to ID3/8" * OD5/8", Lifemeta STF	50 cm x2	ECS Male	1 set
SAL04044		ID1/8" * OD1/4" to ID3/8" * OD5/8", Lifemeta STF	100 cm x2		1 set
SAL04045	ECS	ID1/4" * OD7/16" to ID3/8" * OD5/8", Lifemeta STF	50 cm x2		1 set
SAL04046	Female	ID1/4" * OD7/16" to ID3/8" * OD5/8", Lifemeta STF	100 cm x2		1 set
SAL04047		ID1/4" * OD7/16" to ID1/2" * OD3/4", Lifemeta STF	50 cm x2		1 set
SAL04048		ID1/4" * OD7/16" to ID1/2" * OD3/4", Lifemeta STF	100 cm x2	ECM	1 set
SAL04049		ID3/8" * OD5/8" to ID1/2" * OD3/4", Lifemeta STF	50 cm x2	Male	1 set
SAL04050		ID3/8" * OD5/8" to ID1/2" * OD3/4", Lifemeta STF	100 cm x2		1 set

Figure 3, with TC connectors

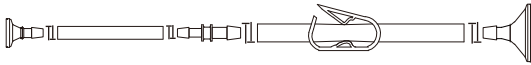

Part No.	Port 1	Tubing	Length	Port 2	Package
SAL04021		ID1/8" * OD1/4" to ID1/4" * OD7/16", C-Flex® 374	50 cm x2		1 set
SAL04022		ID1/8" * OD1/4" to ID1/4" * OD7/16", C-Flex® 374	100 cm x2		1 set
SAL04023		ID1/8" * OD1/4" to ID3/8" * OD5/8", C-Flex® 374	50 cm x2		1 set
SAL04024		ID1/8" * OD1/4" to ID3/8" * OD5/8", C-Flex® 374	100 cm x2		1 set
SAL04025	TC25	ID1/4" * OD7/16" to ID3/8" * OD5/8", C-Flex® 374	50 cm x2	TC50	1 set
SAL04026		ID1/4" * OD7/16" to ID3/8" * OD5/8", C-Flex® 374	100 cm x2		1 set
SAL04027		ID1/4" * OD7/16" to ID1/2" * OD3/4", C-Flex® 374	50 cm x2		1 set
SAL04028		ID1/4" * OD7/16" to ID1/2" * OD3/4", C-Flex® 374	100 cm x2		1 set
SAL04029		ID3/8" * OD5/8" to ID1/2" * OD3/4", C-Flex® 374	50 cm x2		1 set
SAL04030		ID3/8" * OD5/8" to ID1/2" * OD3/4", C-Flex® 374	100 cm x2		1 set
SAL04051		ID1/8" * OD1/4" to ID1/4" * OD7/16", Lifemeta STF	50 cm x2		1 set
SAL04052		ID1/8" * OD1/4" to ID1/4" * OD7/16", Lifemeta STF	100 cm x2		1 set
SAL04053		ID1/8" * OD1/4" to ID3/8" * OD5/8", Lifemeta STF	50 cm x2		1 set
SAL04054		ID1/8" * OD1/4" to ID3/8" * OD5/8", Lifemeta STF	100 cm x2		1 set
SAL04055	TC25	ID1/4" * OD7/16" to ID3/8" * OD5/8", Lifemeta STF	50 cm x2	TC50	1 set
SAL04056		ID1/4" * OD7/16" to ID3/8" * OD5/8", Lifemeta STF	100 cm x2		1 set
SAL04057		ID1/4" * OD7/16" to ID1/2" * OD3/4", Lifemeta STF	50 cm x2		1 set
SAL04058		ID1/4" * OD7/16" to ID1/2" * OD3/4", Lifemeta STF	100 cm x2		1 set
SAL04059		ID3/8" * OD5/8" to ID1/2" * OD3/4", Lifemeta STF	50 cm x2		1 set
SAL04060		ID3/8" * OD5/8" to ID1/2" * OD3/4", Lifemeta STF	100 cm x2		1 set

Single-Use Pump Tubing Sets with TPE Tubing

Figure 1, with tubing plugs



Part No.	Port 1	Tubing	Length	Port 2	Package
SAL05001	Plug	ID1/8" * OD1/4"	25 cm C-Flex® 374 to 50 cm Pharma APT to 25 cm C-Flex® 374	Plug	1 set
SAL05002		ID1/4" * OD7/16"	25 cm C-Flex® 374 to 50 cm Pharma APT to 25 cm C-Flex® 374		1 set
SAL05003		ID3/8" * OD5/8"	25 cm C-Flex® 374 to 50 cm Pharma APT to 25 cm C-Flex® 374		1 set
SAL05004		ID1/2" * OD3/4"	25 cm C-Flex® 374 to 50 cm Pharma APT to 25 cm C-Flex® 374		1 set
SAL05009	Plug	ID1/8" * OD1/4"	25 cm Lifemeta STF to 50 cm Pharma APT to 25 cm Lifemeta STF	Plug	1 set
SAL05010		ID1/4" * OD7/16"	25 cm Lifemeta STF to 50 cm Pharma APT to 25 cm Lifemeta STF		1 set
SAL05011		ID3/8" * OD5/8"	25 cm Lifemeta STF to 50 cm Pharma APT to 25 cm Lifemeta STF		1 set
SAL05012		ID1/2" * OD3/4"	25 cm Lifemeta STF to 50 cm Pharma APT to 25 cm Lifemeta STF		1 set

Figure 2, with EC connectors



Part No.	Port 1	Tubing	Length	Port 2	Package
SAL05005	ECS Female	ID1/8" * OD1/4"	25 cm C-Flex® 374 to 50 cm Pharma APT to 25 cm C-Flex® 374	ECS Male	1 set
SAL05006		ID1/4" * OD7/16"	25 cm C-Flex® 374 to 50 cm Pharma APT to 25 cm C-Flex® 374		1 set
SAL05007		ID3/8" * OD5/8"	25 cm C-Flex® 374 to 50 cm Pharma APT to 25 cm C-Flex® 374		1 set
SAL05008	ECM Female	ID1/2" * OD3/4"	25 cm C-Flex® 374 to 50 cm Pharma APT to 25 cm C-Flex® 374	ECM Male	1 set
SAL05013	ECS Female	ID1/8" * OD1/4"	25 cm Lifemeta STF to 50 cm Pharma APT to 25 cm Lifemeta STF	ECS Male	1 set
SAL05014		ID1/4" * OD7/16"	25 cm Lifemeta STF to 50 cm Pharma APT to 25 cm Lifemeta STF		1 set
SAL05015		ID3/8" * OD5/8"	25 cm Lifemeta STF to 50 cm Pharma APT to 25 cm Lifemeta STF		1 set
SAL05016	ECM Female	ID1/2" * OD3/4"	25 cm Lifemeta STF to 50 cm Pharma APT to 25 cm Lifemeta STF	ECM Male	1 set

Single-Use Y-line Transfer Sets with TPE Tubing

Figure 1, with tubing plugs

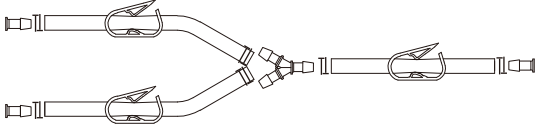

Part No.	Port 1	Tubing	Length	Port 2	Package
SAY01001	Plug	ID1/8" * OD1/4" C-Flex® 374	50 cm x3	Plug x2	1 set
SAY01002		ID1/4" * OD7/16" C-Flex® 374	50 cm x3		1 set
SAY01003		ID3/8" * OD5/8" C-Flex® 374	50 cm x3		1 set
SAY01004		ID1/2" * OD3/4" C-Flex® 374	50 cm x3		1 set
SAY01005	Plug	ID1/8" * OD1/4" Lifemeta STF	50 cm x3	Plug x2	1 set
SAY01006		ID1/4" * OD7/16" Lifemeta STF	50 cm x3		1 set
SAY01007		ID3/8" * OD5/8" Lifemeta STF	50 cm x3		1 set
SAY01008		ID1/2" * OD3/4" Lifemeta STF	50 cm x3		1 set

Figure 2, with EC connectors

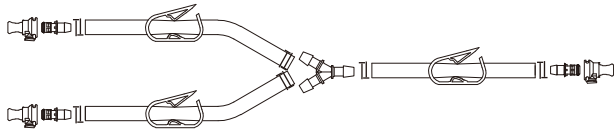

Part No.	Port 1	Tubing	Length	Port 2	Package
SAY02005	ECS Female	ID1/8" * OD1/4" Lifemeta STT	50 cm x3	ECS Male x2	1 set
SAY02006		ID1/4" * OD7/16" Lifemeta STT	50 cm x3		1 set
SAY02007		ID3/8" * OD5/8" Lifemeta STT	50 cm x3		1 set
SAY02008	ECM Female	ID1/2" * OD3/4" Lifemeta STT	50 cm x3	ECM Female x2	1 set

Figure 3, with TC connectors

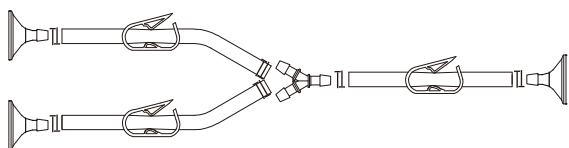

Part No.	Port 1	Tubing	Length	Port 2	Package
SAY03010		ID1/8" * OD1/4" Lifemeta STT	50 cm x3		1 set
SAY03011		ID1/4" * OD7/16" Lifemeta STT	50 cm x3		1 set
SAY03012	TC25	ID3/8" * OD5/8" Lifemeta STT	50 cm x3	TC25 x2	1 set
SAY03013		ID1/2" * OD3/4" Lifemeta STT	50 cm x3		1 set
SAY03014		ID3/4" * OD1" Lifemeta STT	50 cm x3		1 set
SAY03015		ID1/4" * OD7/16" Lifemeta STT	50 cm x3		1 set
SAY03016	TC50	ID3/8" * OD5/8" Lifemeta STT	50 cm x3	TC50 x2	1 set
SAY03017		ID1/2" * OD3/4" Lifemeta STT	50 cm x3		1 set
SAY03018		ID3/4" * OD1" Lifemeta STT	50 cm x3		1 set

Figure 4, with AseptiQuik® G Sterile connectors

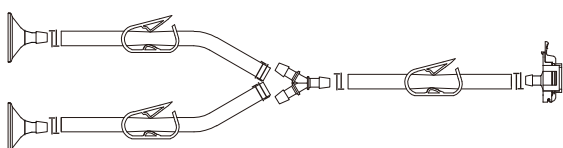

Part No.	Port 1	Tubing	Length	Port 2	Package
SAY05013		ID1/4" * OD7/16" Lifemeta STT	50 cm x3		1 set
SAY05014		ID3/8" * OD5/8" Lifemeta STT	50 cm x3	AseptiQuik® G x2	1 set
SAY05015		ID1/2" * OD3/4" Lifemeta STT	50 cm x3		1 set
SAY05016		ID1/4" * OD7/16" Lifemeta STT	50 cm x3	ECS Male+	1 set
SAY05017	AseptiQuik® G	ID3/8" * OD5/8" Lifemeta STT	50 cm x3	ECS Female	1 set
SAY05018		ID1/2" * OD3/4" Lifemeta STT	50 cm x3	ECM Male+ECM Female	1 set
SAY05019		ID1/4" * OD7/16" Lifemeta STT	50 cm x3		1 set
SAY05020		ID3/8" * OD5/8" Lifemeta STT	50 cm x3	TC25 x2	1 set
SAY05021		ID1/2" * OD3/4" Lifemeta STT	50 cm x3		1 set

Lifemeta Pharmaceutical Grade Connectors



Quality Assurance

- ISO® 9001:2015 quality management system
- ISO Class 7 clean zones
- ADCF raw materials
- Meet the FDA Indirect Food Additive requirements cited in 21 CFR 177-182
- Meet the requirement of USP <87> In Vitro Biological Reactivity Test
- Meet the criteria of the USP <88> Biological Reactivity Test for Class VI plastics
- Aqueous extraction contains < 0.25 EU/mL as determined by Limulus Amebocyte Lysate (LAL), USP <85>
- Particulate matter in the product eluent meets the requirements in USP <788> for large volume parenterals

Lifemeta SF Line to Line Connectors Features

- Polypropylene material. Can be sterilized by gamma irradiation at 25-45 KGY or autoclaved 30 minutes at 126°C
- Can connect with multi pipelines in different sizes of flexible tubings
- Cobetter Self-manufactured, variable and flexible customized services

Lifemeta EC Quick Couplers Features

- No size limit. Can connect freely between Male and Female connectors
- No sterilization method limit (gamma irradiation and autoclave irradiation) . Can connect freely between Male and Female connectors
- Polysulfone material. Can be sterilized by gamma irradiation at 25-45 KGY or autoclaved 60 minutes below 132°C
- Withstand bursting pressure at room temperature from 3.09 to 4.26 Mpa
- Cobetter Self-manufactured with short delivery time

Order Information

Lifemeta SF Line to Line Connectors

Cat. No.	Description	Packaging
SFLTNN	1/8" Hose Barb(HB) to 3/4" Tri-clamp (TC25)	Non-sterile
SFLRTNN	1/4" Hose Barb(HB) to 3/4" Tri-clamp (TC25)	
SFLYTNN	3/8" Hose Barb(HB) to 3/4" Tri-clamp (TC25)	
SFLHTNN	1/2" Hose Barb(HB) to 3/4" Tri-clamp (TC25)	
SFLPTNN	Male Luer Lok to 3/4" Tri-clamp (TC25)	
SFLCTNN	Female Luer Lok to 3/4" Tri-clamp (TC25)	
SFLMTNN	3/4" Hose Barb(HB) to 3/4" Tri-clamp (TC25)	
SFLRSNN	1/4" Hose Barb(HB) to 1-1/2" Tri-clamp (TC50)	
SFLYSNN	3/8" Hose Barb(HB) to 1-1/2" Tri-clamp (TC50)	
SFLHSNN	1/2" Hose Barb(HB) to 1-1/2" Tri-clamp (TC50)	
SFLMSNN	3/4" Hose Barb(HB) to 1-1/2" Tri-clamp (TC50)	
SFLDSNN	1" Hose Barb(HB) to 1-1/2" Tri-clamp (TC50)	
SFLLPNN	1/8" Hose Barb(HB) to Male Luer Lok	
SFLLCNN	1/8" Hose Barb(HB) to Female Luer Lok	
SFLRPNN	1/4" Hose Barb(HB) to Male Luer Lok	
SFLRCNN	1/4" Hose Barb(HB) to Female Luer Lok	
SFYHHHNN	1/2" Hose Barb(HB)- 1/2" HB- 1/2" HB Y-Fitting	
SFTRRRNN	1/4" Hose Barb(HB)- 1/4" HB- 1/4" HB T-Fitting	
SFTYYYNN	3/8" Hose Barb(HB)- 3/8" HB- 3/8" HB T-Fitting	
SFXRRRNN	1/4" Hose Barb(HB)- 1/4" HB- 1/4" HB- 1/4" HB Cross Fitting	
SFYYYYNN	3/8" Hose Barb(HB)- 3/8" HB- 3/8" HB- 3/8" HB Cross Fitting	

Lifemeta EC Quick Couplers

Cat. No.	Description	Packaging
ECSSMLNN	ECS Coupling Inserts-1/8" Hose Barb(HB)	Non-sterile
ECSSMRNN	ECS Coupling Inserts-1/4" Hose Barb(HB)	
ECSSMYNN	ECS Coupling Inserts-3/8" Hose Barb(HB)	
ECSSMPNN	ECS Sealing Plug	
ECSSFLNN	ECS Female Coupler-1/8" Hose Barb(HB)	
ECSSFRNN	ECS Coupling Bodies-1/4" Hose Barb(HB)	
ECSSFYNN	ECS Coupling Bodies-3/8" Hose Barb(HB)	
ECSSFPNN	ECS Sealing Cap	

* For more pre-designed solutions, please contact Cobetter sales or technical assistance.

Our Mission

Through Excellent Products & Sustainable Innovative Solutions,
We Help Customers Solve Process Problems & Increase Yield.

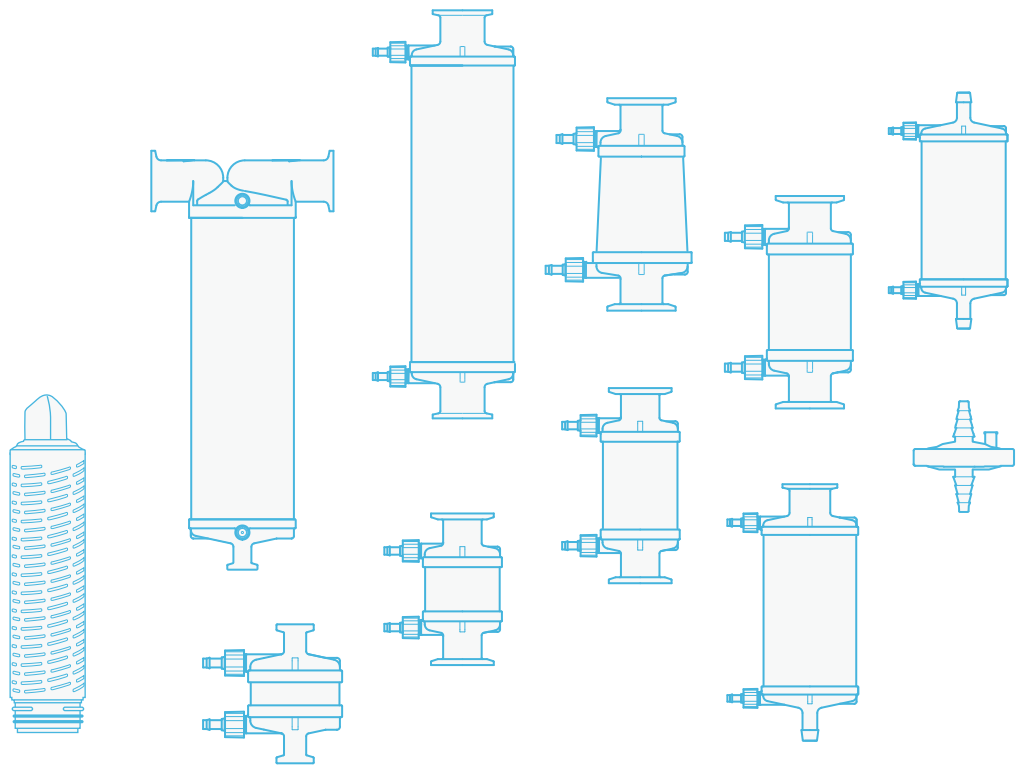

Please contact us for more information
Hangzhou Cobetter Filtration Equipment Co.,Ltd.

Sales Add 13-18 F, Building 1, Zicheng International Innovation Center,
No.39 Jincheng Road, Xiaoshan District, Hangzhou 311215, China

Factory Cobetter Park, Heshang New Material Industrial Park, Xiaoshan District, Hangzhou 311265, China

Tel 400-070-4266

Fax +86-571-87704256

www.cobetterfiltration.com